

OMRON  
Digital Automatic Blood Pressure Monitor

Model **HEM-907**



## INSTRUCTION MANUAL

Thank you very much for purchasing the OMRON Digital Automatic Blood Pressure Monitor.

Please read this Instruction Manual thoroughly to ensure safe and correct use of the monitor.



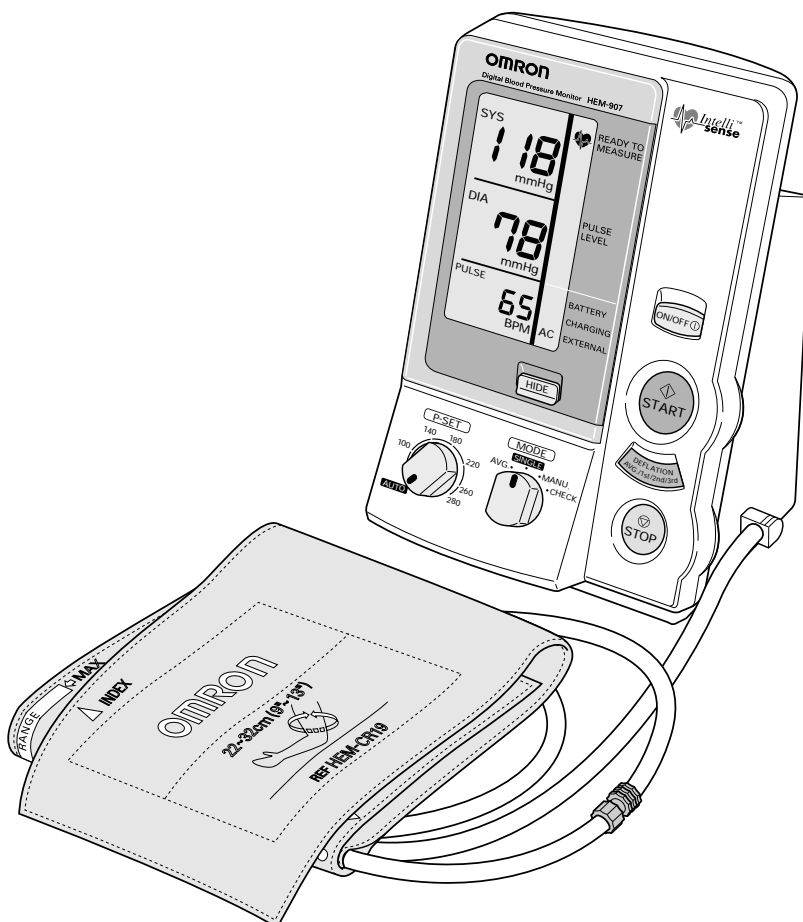

Please keep this Instruction Manual for future reference.

### Table of Contents

<b>Be Sure to Read This Section</b>	
Notes on Safety.....	1
<b>Know Your Unit</b>	
Features of the Product.....	4
Components of the Product .....	5
Options .....	6
Names and Functions of the Parts.....	7
Names of the Parts.....	7
Functions and setting while the unit is in use .....	9
<b>Preparations before Measurement</b>	
How to Apply the Cuff .....	11
How to Use the Power Source .....	13
How to Use the AC Adapter.....	13
Installation and Replacement of Battery Pack .....	14
<b>How to Measure Blood Pressure</b>	
How to Measure Blood Pressure .....	15
SINGLE Mode .....	16
AVG. Mode .....	18
MANU. Mode.....	20
CHECK Mode .....	22
How to Clean the Unit after Use .....	23
List of Error Codes .....	24
Troubleshooting .....	25
<b>Specifications</b>	
Specifications .....	26
Exemptions on warranty.....	27
MEMO (Blank pages).....	28-30





# Notes on Safety

⚠ Warning	
<p>When a person other than the doctor or medical employee uses this monitor, self-diagnosis of the measured results or treatment is dangerous. Please consult and follow the instruction of the doctor.</p> <ul style="list-style-type: none"> <li>• Self-diagnosis may worsen the disease.</li> </ul> <p>If you encounter any problem during measurement such as inflation does not stop, remove the cuff or pull out the air tube from the main unit.</p> <ul style="list-style-type: none"> <li>• If inflation does not stop, there is danger of peripheral neuropathy.</li> </ul> <p>If the fluid inside the battery gets in your eye, rinse the eye with lots of water without rubbing, then seek medical treatment immediately.</p> <ul style="list-style-type: none"> <li>• If left unattended, there is danger of loss of eyesight.</li> </ul>	
<p>Do not wrap the cuff over the arm where intravenous injection or transfusion is being conducted.</p> <ul style="list-style-type: none"> <li>• Intravenous injection or transfusion will not be possible.</li> </ul> <p>Do not erroneously connect the air tube or the cuff to the tube of other equipment connected to intracorporeal organ.</p> <ul style="list-style-type: none"> <li>• Air may get into the blood vessels.</li> </ul>	
<p>Do not use this unit in places where inflammable gas, such as highly inflammable anesthetic, may be generated or in a high-pressure oxygen room or an oxygen tent.</p> <ul style="list-style-type: none"> <li>• It may cause ignition and explosion.</li> </ul> <p>Do not use the exclusive battery pack (option) for other equipment. Do not throw the battery pack into fire, or heat, or disassemble it.</p> <ul style="list-style-type: none"> <li>• It may cause heat, ignition, short-circuit or rupture.</li> </ul>	
<p>Do not touch the AC adapter with wet hands.</p> <ul style="list-style-type: none"> <li>• You may suffer electric shock.</li> </ul>	
<p>If you are going to leave this unit unused for a long time, be sure to unplug the AC adapter from the electric outlet.</p> <ul style="list-style-type: none"> <li>• This is to avoid danger of electric shock, electric leak or fire due to deteriorated insulation.</li> </ul> <p>Be sure to unplug the AC adapter from the electric outlet when installing, removing, or cleaning the part(s).</p> <ul style="list-style-type: none"> <li>• This is to avoid danger of electric shock or injuries.</li> </ul>	

# Notes on Safety

## ⚠ Caution

<p>In the following cases, check the readings with the stethoscope.</p> <p>(1) When an irregular pulse wave is displayed</p> <ul style="list-style-type: none"> <li>• The reading may be erroneous due to external vibration or patient's body movement.</li> </ul> <p>(2) When erroneous reading takes place or the measured value is doubtful</p> <ul style="list-style-type: none"> <li>• The reading may be erroneous due to external vibration or patient's body movement.</li> <li>• An error may have occurred or the blood pressure cannot be measured for patient with peripheral circulatory disturbance or extreme hypotension.</li> <li>• An error may occur if patient has extremely short variation of blood pressure such as arrhythmia.</li> </ul> <p>Be sure to use the AC adapter appropriate for your country.</p> <ul style="list-style-type: none"> <li>• If not, it may cause fire or you may suffer electric shock.</li> </ul> <p>Do not share an electric outlet with other unit or electric appliance.</p> <ul style="list-style-type: none"> <li>• It may cause fire or you may suffer electric shock.</li> </ul> <p>After cleaning this unit, dry it well, then plug the AC adapter in the electric outlet.</p> <ul style="list-style-type: none"> <li>• If not, you may suffer electric shock.</li> </ul> <p>Insert the AC adapter to the electric outlet as far as it goes. Do not use the AC adapter with dust accumulated on it.</p> <ul style="list-style-type: none"> <li>• There is danger of electric shock, or there may be short circuit or fire ignition.</li> </ul> <p>If you encounter any trouble with the main unit, immediately stop using, turn off the unit, unplug the AC adapter from the electric outlet, then contact the repair department.</p> <ul style="list-style-type: none"> <li>• There is danger of electric shock, or there may be short circuit or fire ignition.</li> </ul>	
<p>Do not disassemble or remodel this unit.</p> <ul style="list-style-type: none"> <li>• There is danger of electric shock or injury, or there may be fire, or trouble.</li> </ul>	
<p>Do not use any cuff other than the one exclusive for this unit.</p> <ul style="list-style-type: none"> <li>• If not, result may be erroneous.</li> </ul> <p>Do not use this unit on infants.</p> <ul style="list-style-type: none"> <li>• Blood pressure may not be measured correctly.</li> </ul> <p>Do not use this unit on patient using a pump oxygenator.</p> <ul style="list-style-type: none"> <li>• The unit can not measure correctly.</li> </ul> <p>Do not use AC adapter and battery pack that are not specified for this unit.</p> <ul style="list-style-type: none"> <li>• It may cause fire or you may suffer electric shock.</li> </ul> <p>Do not short-circuit the polarities of the optional battery pack with a metal object such as wire. If the fluid in the battery drip on your skin or clothes, immediately wash off the fluid with water.</p> <ul style="list-style-type: none"> <li>• You may suffer injury.</li> </ul>	

# Notes on Safety

## Caution

Do not use a cellular phone near this unit.

- This unit may malfunction.

Do not use this unit in a moving vehicle.

- This may result in erroneous measurement.

Do not install parts and/or instrument that are not specified for this unit.

- It may cause damage to the unit.

Do not use broken power cord or AC adapter, or loose electric outlet.

- There is danger of electric shock, or there may be short circuit or fire ignition.

Do not pull the power cord when unplugging the AC adapter from the electric outlet.

- The power cord will be disconnected or short-circuited, and may cause fire or you may suffer electric shock.

Do not scratch, damage, modify, forcibly bend, pull, twist, bundle the cord of AC adapter, or place heavy materials on it, or pinch it.

- You may suffer electric shock or there may be electric leak and fire because of deteriorated insulation.



Do not install or store this unit where it may be sprayed with water or medication.

- There is danger of electric shock.



## General advice

Do not place or put anything on this unit.

Do not apply strong shock to or drop this unit.

Turn off power and unplug the AC adapter from the electric outlet before moving the unit.

Read the instruction manual of the other devices to be used at the same time with this unit, to understand and be aware of the interaction between the devices.

Before using the unit

- Check if all cords and tubes are securely connected.
- Operate the Buttons to check that this unit operates normally before use.

When using the unit

- Do not inflate the cuff without being wrapped over the arm.
- Do not use torn cuff.
- Be sure that the patient do not touch the Buttons of this unit.

After using the unit

- Clean and store this monitor and accessories.
- Do not clean this unit with gasoline, paint thinner, or high concentration alcohol.
- Do not disinfect this unit by autoclave or gas sterilization (EOG, formaldehyde, or high concentration ozone).

Do not install or store this unit in the following places.

- Under direct sunlight
- Dusty or salty environment
- At an inclined position, or subject to vibration and/ or shock
- Storage of chemicals or where gas may be generated
- At high temperature and high humidity

# Features of the Product

OMRON Digital Automatic Blood Pressure Monitor, Model HEM-907 is developed to measure blood pressure with accuracy and simple operation in the doctor's consultation room or at bedside.

- **One-push operation**

Just by wrapping the cuff and pushing the START Button (to start measurement), blood pressure and pulse rate can be measured. Measurement is made by oscillometric method.

- **Automatic pressure setting**

When the P-SET (Pressure Setting) Knob is set to "AUTO," this unit will automatically inflate the cuff to the optimal pressure according to each patient's blood pressure. Cumbersome pressure value setting operation is not necessary.

- **Large and easy to read display**

With the use of an LCD display, display of figures is large and easy to read.

- **Quiet operation**

Because this unit is designed for quiet operation, it can be used in the hospital room at night.

- **Average Mode (AVG. Mode)**

Just by wrapping the cuff and pushing the START Button (to start measurement), this unit will automatically start to measure for two or three times. After the measurements, the average values of systolic and diastolic blood pressures and pulse rate of measurements are displayed. The results of each measurement can also be called. By changing the setting, the number of measurements and the interval can be changed.

- **Auscultation Mode (MANU. Mode)**

This unit can measure blood pressure by using a stethoscope. The unit inflates and deflates the cuff automatically, then displays the pressure values. As the pressures during deflation are digitally displayed and synchronized with the pulse rate, they can be read with accuracy. The deflation speed after confirming the systolic pressure and immediately before the diastolic pressure can be accelerated.

**INTELLISENSE blood pressure monitor** is a global brand name of blood pressure monitor equipped with bio-information sensing and high performance fuzzy logic technology, which are the key technologies of OMRON. With this excellent sensing technology, the monitor can achieve "accurate measurement".

# Components of the Product

## Main unit

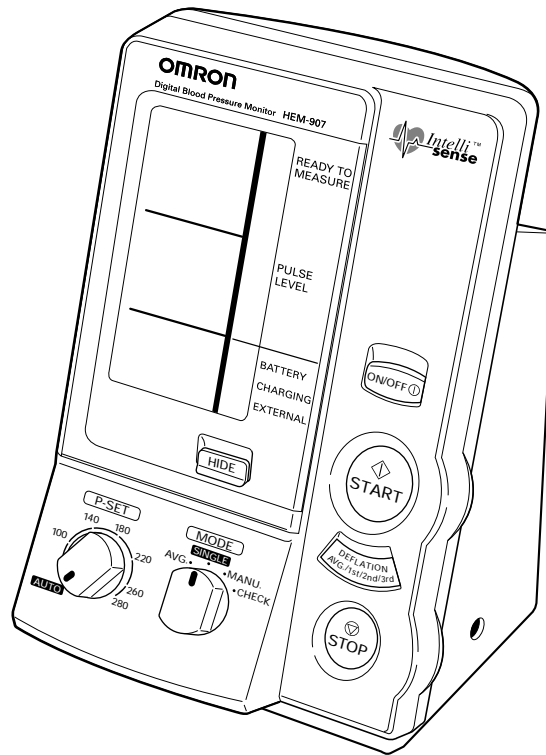

## Accessories

### Cuff / bladder set M \*

Model: HEM-970-CR19  
Applicable arm circumference:  
22 to 32 cm

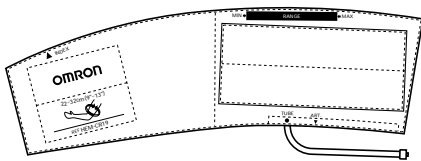

### Air tube 1.0m (39 1/3") \*

Model: HEM-TUBE-100

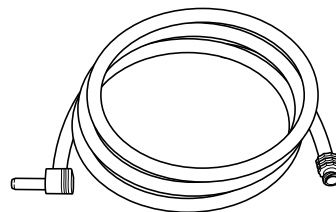

### AC adapter

Model: (Refer to OMRON dealer for the appropriate AC adapter).

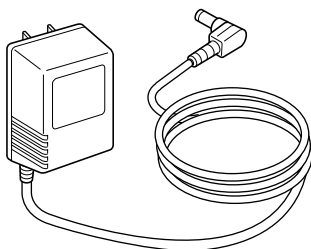

Note: Actual AC adapter may look different from illustration.

# Components of the Product

## Options

Cuff / bladder set L  
(with built-in bladder) \*  
Model: HEM-907-CL19  
Applicable arm circumference:  
32 to 42 cm

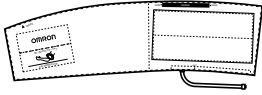

Cuff / bladder set M  
(with built-in bladder) \*  
Model: HEM-907-CR19  
Applicable arm circumference:  
22 to 32 cm

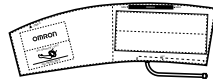

Cuff / bladder set S  
(with built-in bladder) \*  
Model: HEM-907-CS19  
Applicable arm circumference:  
17 to 22 cm

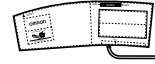

## Cuff (three types) \*

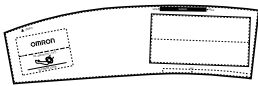

Cuff L (with no bladder)  
Model: HEM-907-CUFFL

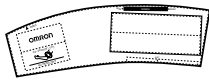

Cuff M (with no bladder)  
Model: HEM-907-CUFFM

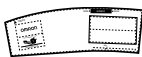

Cuff S (with no bladder)  
Model: HEM-907-CUFFS

## Bladder (three types) \*

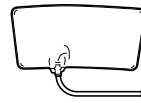

Bladder L  
Model: HEM-907-BLDRL

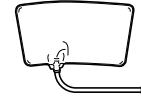

Bladder M  
Model: HEM-907-BLDRM

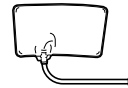

Bladder S  
Model: HEM-907-BLDRS

Air tube 1.3 m \*  
Model: HEM-TUBE-130

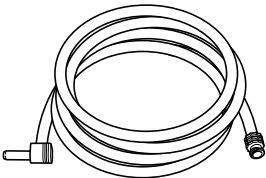

Air tube 1.0 m \*  
Model: HEM-TUBE-100

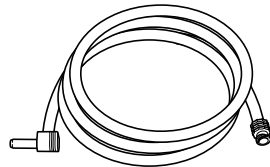

AC adapter  
Model: (Refer to OMRON  
dealer for the appropriate AC  
adapter).

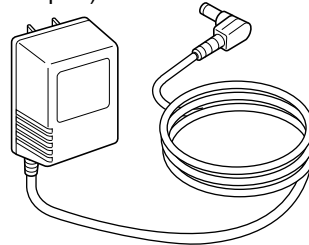

Battery pack (48H907N) \*  
Model: HEM-907-PBAT

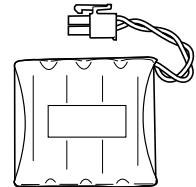

Stand exclusive for this unit \*  
Model: HEM-907-STAND

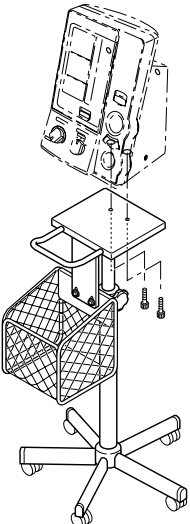

Wall-hanging kit \*  
Model: HEM-907-WKIT

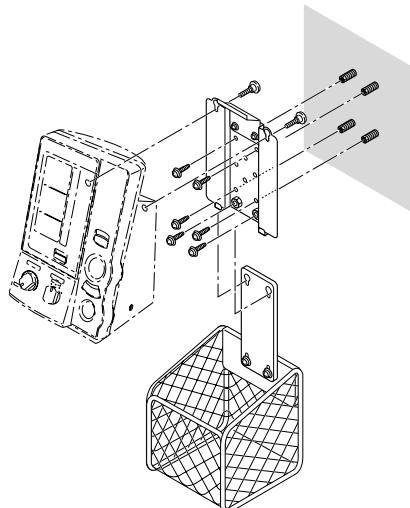

Pole-mounting kit \*  
Model: HEM-907-PKIT

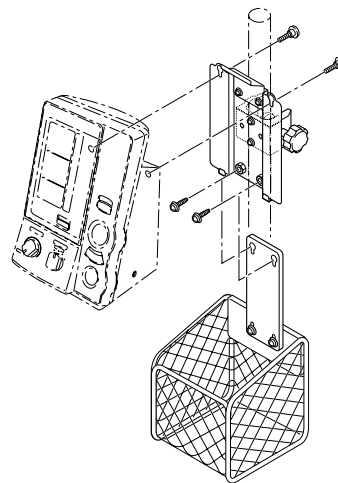

Items attached with an asterisk (\*) are consumables and not covered by the guarantee.

Please understand that the specifications of accessories and options are subject to change without prior notice.

# Names and Functions of the Parts

## Names of the Parts

### Main unit

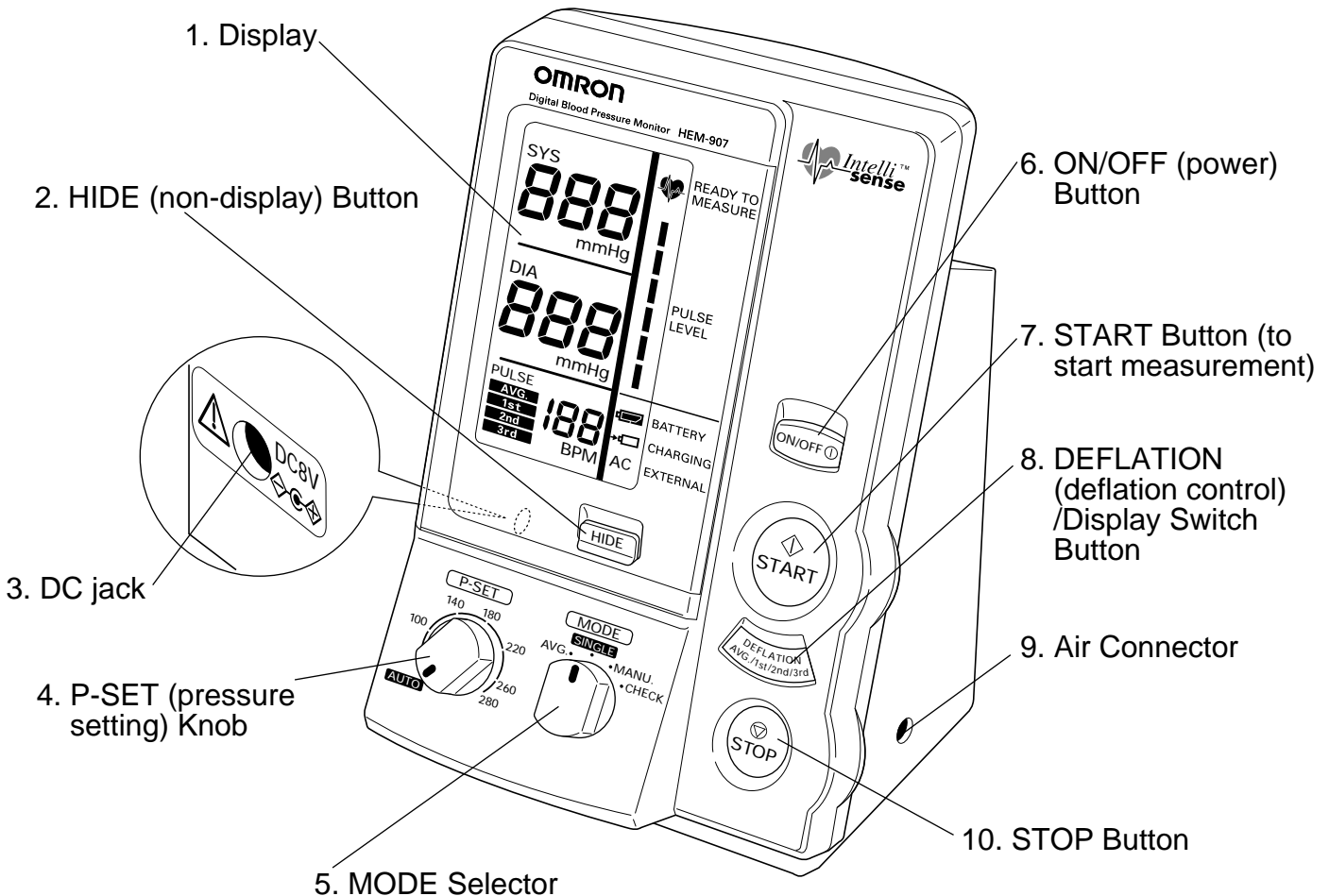

**1. Display:** Displays blood pressure values, pulse rate, and pulse wave level.

**2. HIDE Button:** Switches between display and non-display of measured results.

**3. DC jack:** Connects the AC adapter.

**4. P-SET (pressure setting) Knob:** In the AUTO position, inflation pressure is automatically set. Otherwise, inflation pressure can be set between 100 and 280 mmHg.

**5. MODE Selector:** Selects the mode of measurement.

- One-time Measurement Mode (SINGLE Mode): Measurement with automatic inflation
- Average Mode (AVG. Mode): Automatically measures two (or three) times consecutively.
- Auscultation Mode (MANU. Mode): Automatic inflation, automatic deflation, and pressure display (does not measure blood pressure).
- Check Mode (CHECK Mode): Checks the accuracy of pressure display. Displays only pressure.

**6. ON/OFF (power) Button:** Turns on or off the power of the unit.

**7. START Button :** Starts the measurement.

**8. DEFLATION (deflation control) /Display Switch Button:**

- In the MANU. Mode; Deflates the cuff by approximately 5 to 10 mmHg with each push of the button.
- In the AVG. Mode; Switches the display of average values and the measurement results with each push.

**9. Air Connector:** Connects the air tube.

**10. STOP Button:** Stops the measurement and deflates air rapidly.





# Names and Functions of the Parts

## Functions and setting while the unit is in use

### (1) Pressure setting function

A function that can switch the pressure setting

Inflation can be set by AUTO (automatic setting) method or the pressure value setting method.

**AUTO (Automatic setting):** Can be used when the SINGLE, AVG., or MANU. Mode is selected. The unit estimates the systolic blood pressure value during inflation and inflates to an appropriate cuff pressure.

**Pressure value setting method:** Pressure value can be set between 100 and 280 mmHg. Set the pressure value at about 30 to 40 mmHg higher than the expected systolic pressure.

- To set the P-SET to "AUTO," turn the P-SET Knob counterclockwise as far as it goes until you can hear a click sound.
- In the "AUTO" setting, proper inflation may not be possible when the systolic blood pressure is expected to be more than 220 mmHg. Use the unit in the pressure value setting method.
- If the cuff cannot be inflated to the pressure necessary for the measurement, it may be re-inflated automatically.

### (2) Non-display function

A function not to display measurement results. However, the cuff pressure during measurement is displayed.

This function can be used in the SINGLE and AVG. Modes.

By each push of the  Button, display or non-display of the measurement results is switched.

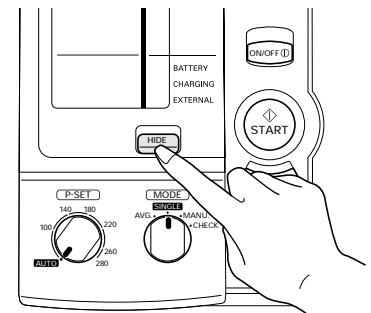
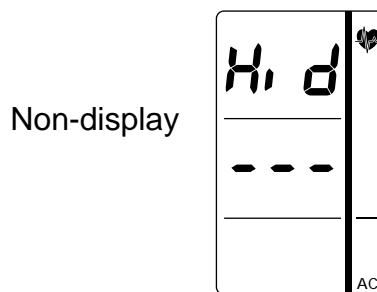
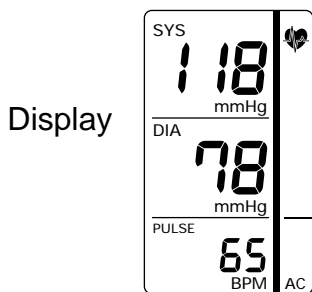

### (3) Manual deflation control function

A function to accelerate deflation by pushing the DEFLATION (deflation control) / Display Switch Button during deflation.

This function can be used in the MANU. Mode.

With each push of the  Button, deflation speed is accelerated by 5 to 10 mmHg.

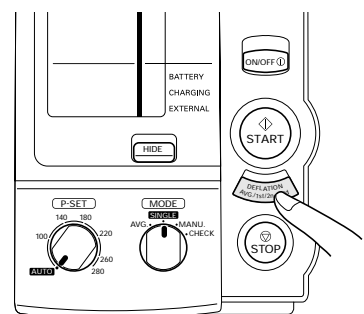

# Names and Functions of the Parts

List of Functions for each Mode

Measurement Mode Function	Single measurement (SINGLE)	Average (AVG.)	Auscultation (MANU.)	Check (CHECK)
Pressure setting function	○	○	○	—
Non-display function	○	○	—	—
Manual deflation control function	—	—	○	—

## (4) Function setting

You can set the number of measurements, the waiting time until the start of 1st measurement, and the measurement interval for the AVG. Mode.

Items to set	Set value
F1 Number of measurements	<b>2 times</b> , 3 times
F2 Waiting time until the start of 1st measurement	<b>0 sec</b> , 3 min, 5 min, and 10 min.
F3 Measurement interval	5 sec, 30 sec, <b>1 min</b> , and 2 min.

Note: The bold letters represent the factory-set values.

### Procedure to change the set values

1) When the power is OFF, push the ON/OFF (power) Button for more than three seconds while holding the START Button and change the mode to the Setting Change Mode. (F1 is displayed.)

2) Push the START Button and select the items from F1 to F3. Each time you push the START Button, the items change in the order of  $F1 \rightarrow F2 \rightarrow F3$ .

3) Push the DEFLATION (deflation control)/ Display Switch Button to change the set values.

4) When the setting is finished, push the ON/OFF (power) Button to turn off the power. The setting is now changed.

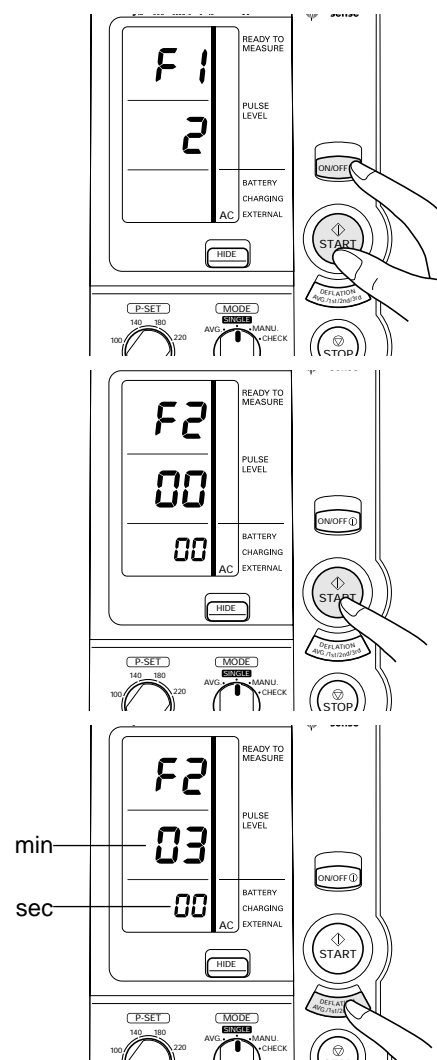

# How to Apply the Cuff

The cuff of OMRON Digital Automatic Blood Pressure Monitor HEM-907 plays an important role of collecting the information on blood vessels. Please wrap the cuff correctly according to the procedure.

## Warning

Do not wrap the cuff over the arm to which intravenous injection or transfusion is being conducted.

- Intravenous injection or transfusion will be impossible.

Do not erroneously connect the air tube or the cuff to the tube of other equipment connected to intracorporeal organ.

- Air may get into blood vessel.



## General advice

- Do not inflate the cuff before it is wrapped over the arm.
- Do not use torn cuff.

### 1. Select the cuff according to the arm circumference of the patient.

Arm circumference	Name of the cuff
17 - 22 cm	Cuff / bladder set S (option)
22 - 32 cm	Cuff / bladder set M
32 - 42 cm	Cuff / bladder set L (option)

- Use cuff that is suitable for the size of the patient's arm.
- If a cuff not suitable for the arm size is used, blood pressure may not be measured correctly.
- Check the following before wrapping the cuff.
  - 1) The bladder is securely installed in the cuff.
  - 2) The bladder is not twisted inside the cuff.
  - 3) The bladder tube is protruding from the cuff as shown in the Figure on the right.

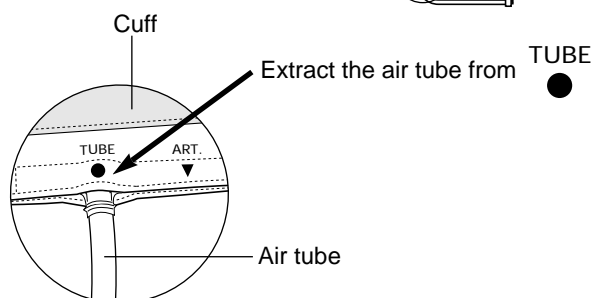
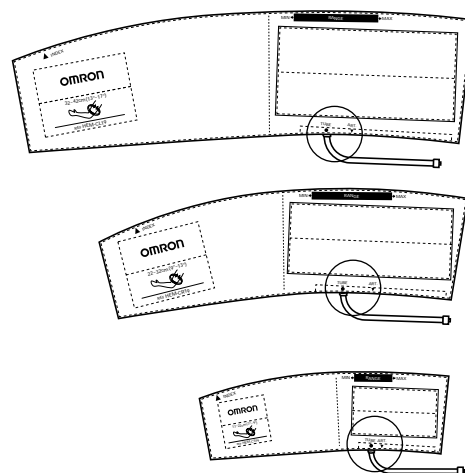

Enlarged figure of the circled part

### 2. Connect the air tube securely.

- When connecting the air tube to the main unit, securely connect the air plug to the base of the air connector.
- Securely connect the air tube and the cuff/bladder set by rotating them as shown in the Figure.
- If you connect the attached 1 m air tube, the air tube can be used with the entire length of 1.2 m.

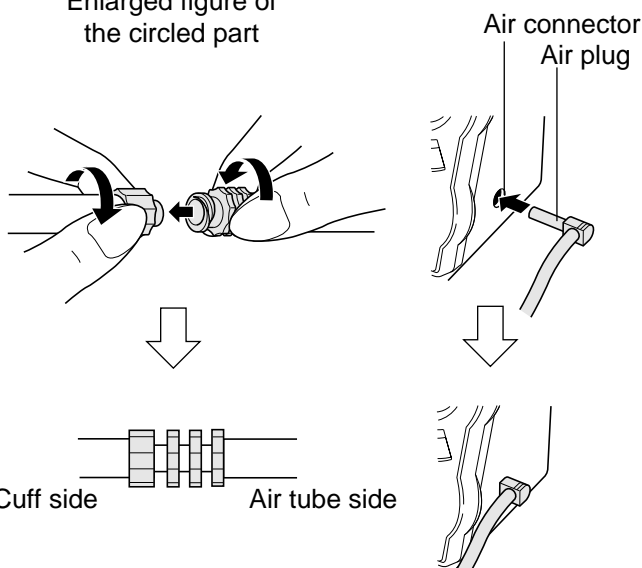

### 3. Prepare the patient to be ready to wrap the cuff.

- Wrap the cuff directly on the arm as a rule.
- If the cuff is wrapped over a thick cloth or by rolling up a jacket or a shirt, blood pressure may not be measured correctly.

# How to Apply the Cuff

4. Place the right hand of the patient with the palm of hand facing upward.

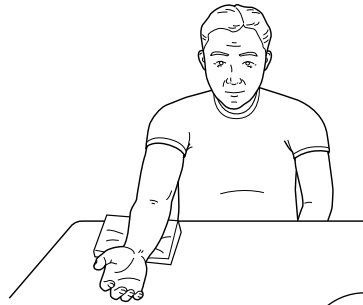

5. Align the Artery Position Mark <sup>ART.</sup> with the brachial artery.

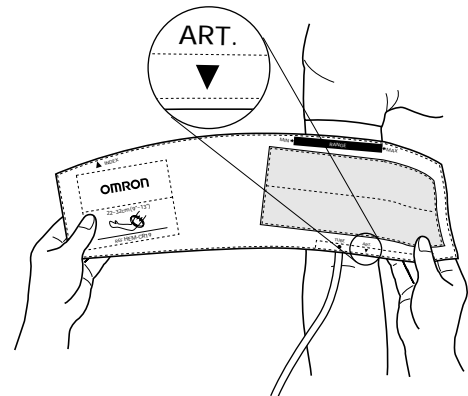

6. Wrap the cuff snugly using both hands and securely fasten it with the Velcro tape. At this time, the lower edge of the cuff must be placed 1.2 cm to 2.5 cm above the inner side of elbow joint.

- If the INDEX is positioned outside the RANGE, select the cuff suitable for the patient's arm circumference and wrap it again.
- If the cuff is not wrapped snugly, blood pressure may not be measured correctly.
- The cuff wrapped diagonally along the shape of the arm does not affect the measurement value.

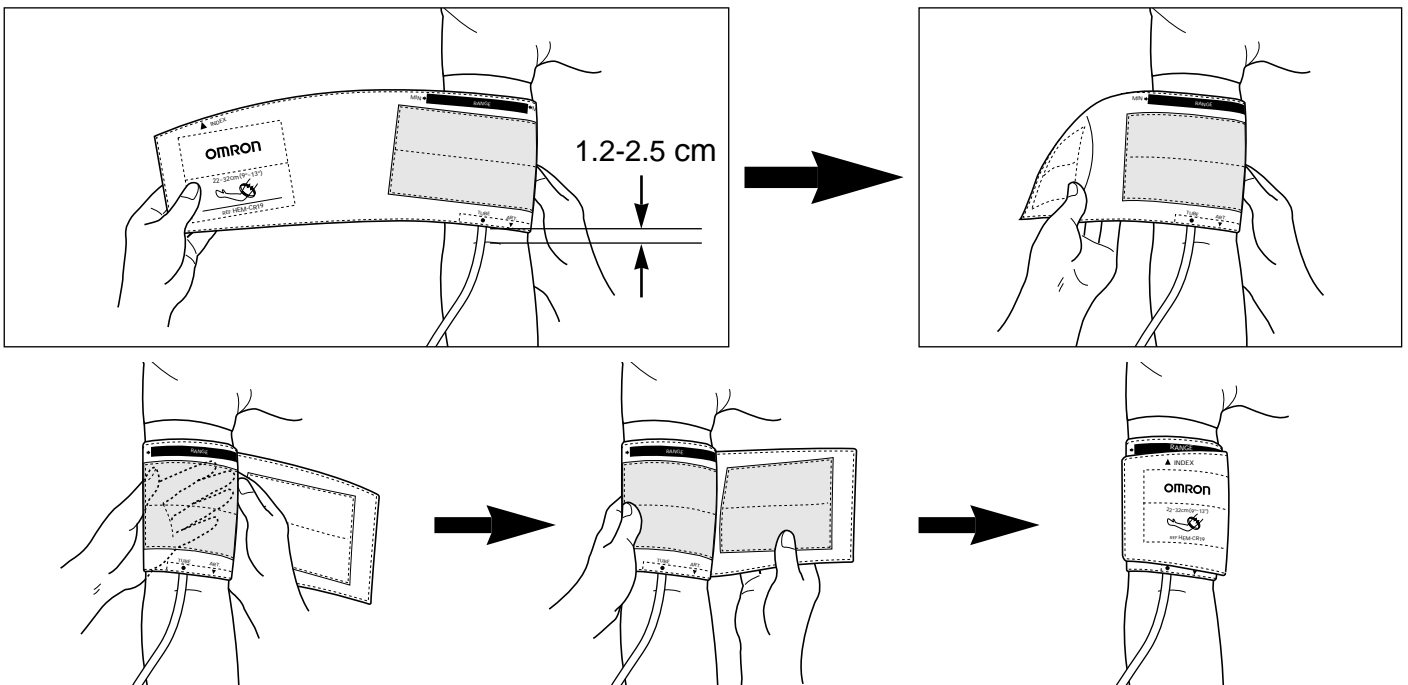



7. Keep the level of the cuff at the same level as the heart during the measurement.

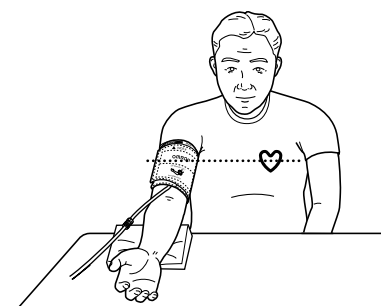

- For the correct measurement, keep the level of the cuff to the same level as the heart.



# How to Use the Power Source

## How to use the AC adapter

<b>Warning</b>	
Do not use this unit in places where inflammable gas, such as highly inflammable anesthetic, may be generated or in a high pressure oxygen room or an oxygen tent. <ul style="list-style-type: none"><li>• It may cause ignition and explosion.</li></ul>	
Do not touch the AC adapter with wet hands. <ul style="list-style-type: none"><li>• You may suffer electric shock.</li></ul>	

<b>Caution</b>	
Be sure to use the AC adapter appropriate for your country. <ul style="list-style-type: none"><li>• It may cause fire or you may suffer electric shock.</li></ul>	
Do not install or store this unit where it may be sprayed with water or medication. <ul style="list-style-type: none"><li>• You may suffer electric shock.</li></ul>	

<b>General advice</b>
<ul style="list-style-type: none"><li>• Read the instruction manual of the other devices to be used at the same time with this unit to understand and be aware of the interaction between the devices.</li><li>• Be sure to operate the Buttons to check this unit for correct operation.</li></ul>

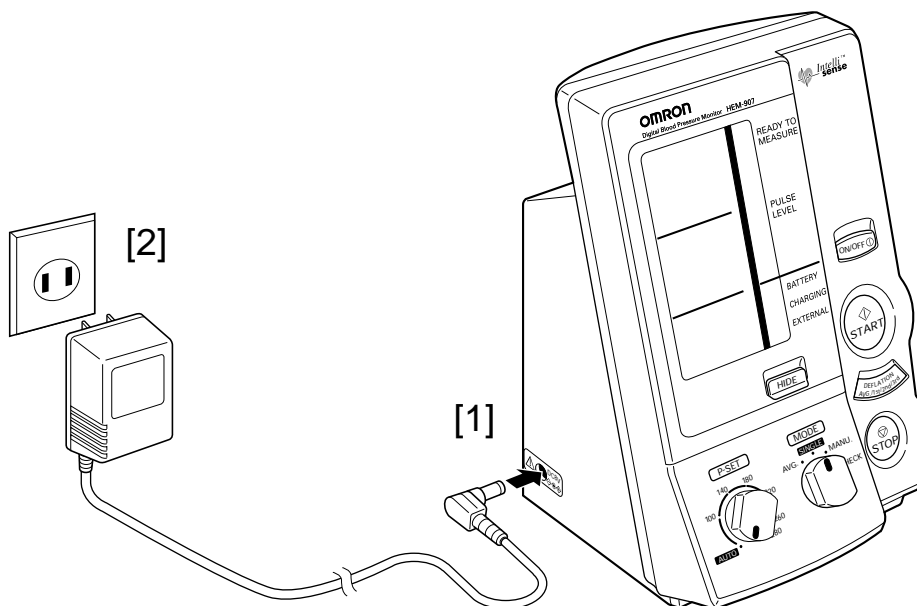

Connect the AC adapter to the DC jack of the main unit [1] and the electric outlet [2].



- When using the optional battery pack 48H907N (Model: HEM-907-PBAT), the unit also function as the charger.

# How to Use the Power Source

## Installation and Replacement of Battery Pack (option)

⚠Warning	
If the fluid in the battery gets into your eye, wash the eye with sufficient water without rubbing the eye, then immediately consult the doctor for treatment. <ul style="list-style-type: none"><li>• There is danger in losing your eyesight.</li></ul>	
Do not use the exclusive battery pack (option) other than for this unit. Do not throw the battery pack into fire, or heat, or disassemble it. <ul style="list-style-type: none"><li>• It may cause heat, ignition, short-circuit, or rupture.</li></ul>	

⚠Caution	
Do not short-circuit the polarities of the optional battery pack with a metal object such as wire. If the fluid in the battery is stained on your skin or clothes, immediately wash off the fluid with water. <ul style="list-style-type: none"><li>• You may suffer injury, or the battery may leak, heat, ignite fire, or explode.</li></ul>	

1. Remove the two screws on the upper portion of the cover of this unit, then remove the battery cover.
2. **Installation:** Connect the battery pack to the connector in the battery cover to install it.  
**Replacement:** Disconnect the battery pack from the connector and replace with a new one.
3. Install the battery cover and fasten it with screws. At this time, be careful not to pinch the lead wire.
4. Connect the main unit and the AC adapter, then charge the battery pack. The battery pack is not charged when you purchase the monitor. When you use the battery pack for the first time, charge it for more than twelve hours before use.

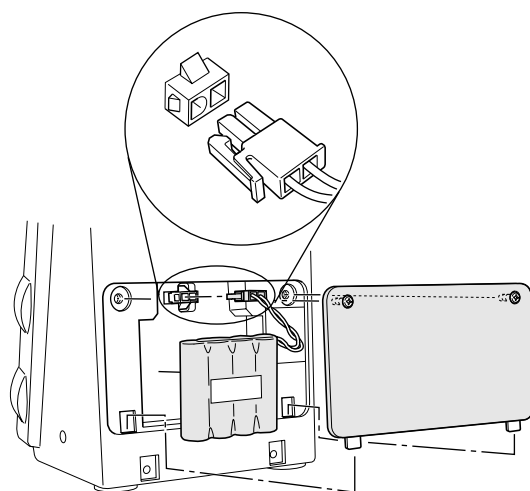



### Battery life

- You can use the unit for approximately three hundred measurements with one charge.
- Approximate life of battery pack is two years. However the battery pack life from each charging may be shortened depending on the state of using. If the interval between charging becomes short and a  mark appears frequently, replace it.

### Charging time

- At approximately five seconds after connecting the AC adapter, the battery pack will start charging automatically.
- While the battery is being charged, a  mark turns on.
- The battery can be charged in approximately twelve hours.

### Battery low



- Even after a  mark starts to blink, you can use the battery for twenty to thirty measurements. However if the Battery Low Mark starts to blink, charge it soon.
- If a  mark is displayed, the battery is low (blood pressure cannot be measured.) Please charge the battery.

### Automatic Power Off

- If you use the unit with the battery pack, the unit will turn off automatically in approximately five minutes even if you forget to turn off the power.
- While the AC adaptor is connected, the Auto Power Off function does not work.

# How to Measure Blood Pressure

⚠Warning	
<p>If any abnormal matter occurs during the measurement such as inflation does not stop, remove the cuff or pull out the air tube from the main unit.</p> <ul style="list-style-type: none"> <li>You may suffer peripheral neuropathy.</li> </ul>	
General advice	
<ul style="list-style-type: none"> <li>Be sure that the patient should not touch the unit.</li> </ul>	

⚠Caution	
<p>In the following cases, check the readings with the stethoscope.</p> <p>(1) When an irregular pulse wave is displayed</p> <ul style="list-style-type: none"> <li>The reading may be erroneous due to external vibration or patient's body movement.</li> </ul> <p>(2) When erroneous reading takes place or the measured value is doubtful</p> <ul style="list-style-type: none"> <li>The reading may be erroneous due to external vibration or patient's body movement.</li> <li>An error may have occurred during measurement or when measurement is not possible for patient who has peripheral circulatory disturbance or extreme hypotension.</li> <li>An error may have occurred due to extreme short variation of blood pressure such as arrhythmia.</li> </ul>	
<p>Do not use cellular phone near the unit.</p> <ul style="list-style-type: none"> <li>The unit may malfunction.</li> </ul> <p>Do not use this unit in a vehicle.</p> <ul style="list-style-type: none"> <li>It may result in erroneous measurement.</li> </ul>	

## List of Measurement Modes

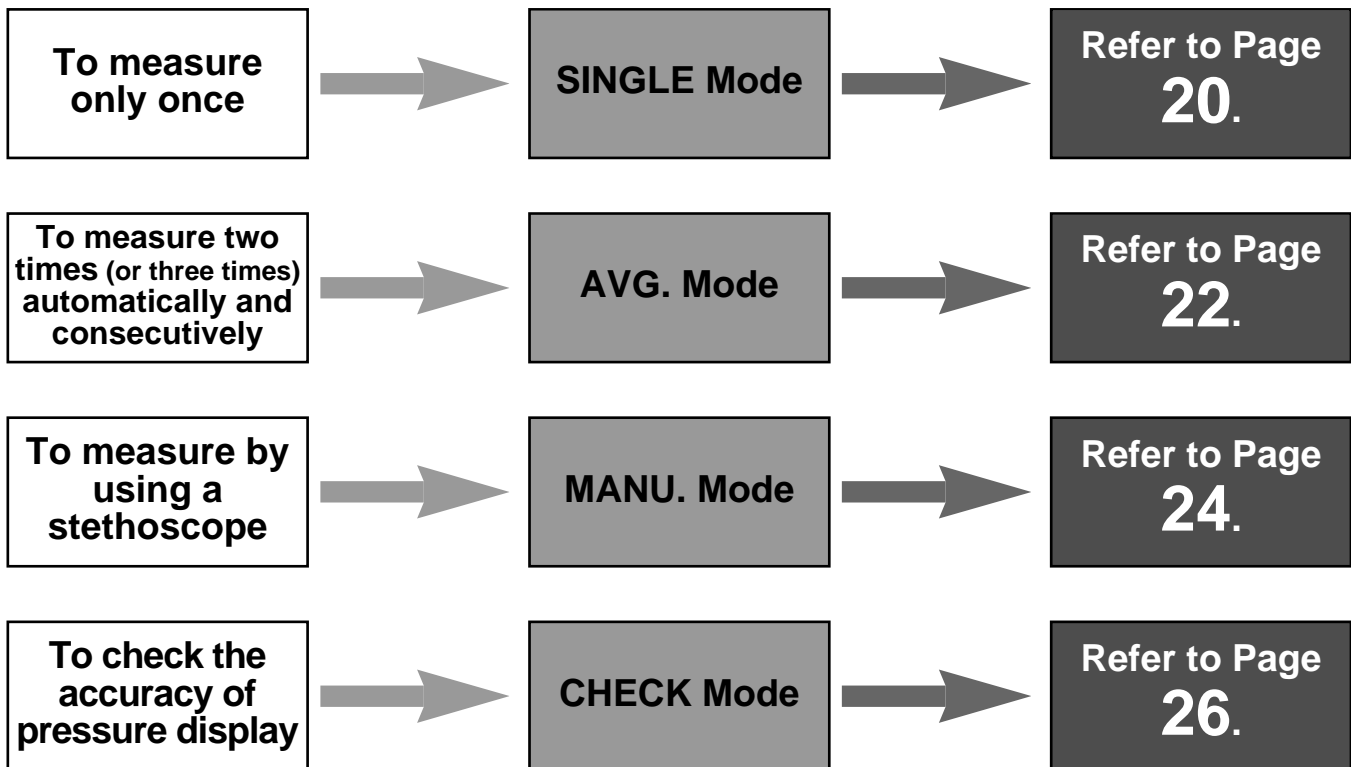



# How to Measure Blood Pressure (in SINGLE Mode)

1. Push the ON/OFF (power) Button to turn on the power.

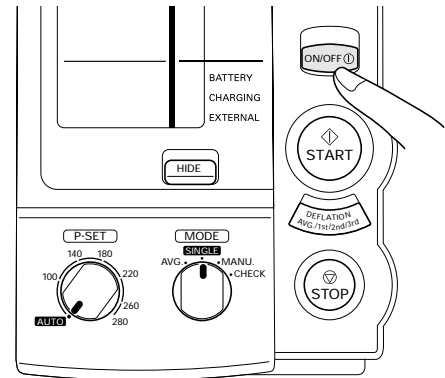

2. Set the MODE Selector to "SINGLE".

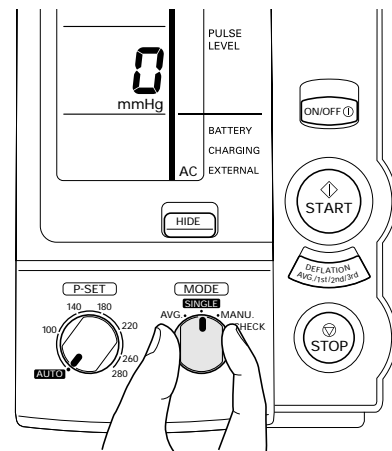

3. Set the P-SET (pressure setting) Knob to "AUTO" or to the target inflation-pressure value.

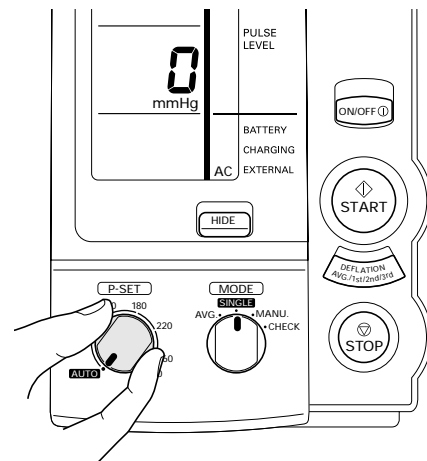

4. Wrap the cuff around the patient's arm. (Refer to Pages 11 and 12.)

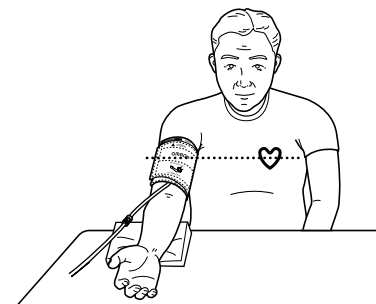

# How to Measure Blood Pressure (in SINGLE Mode)

5. Push the START Button to start the measurement.

- Do not push the START Button without wrapping the cuff on the arm.
- If you want to stop measurement, push the STOP Button. The unit will deflate quickly.

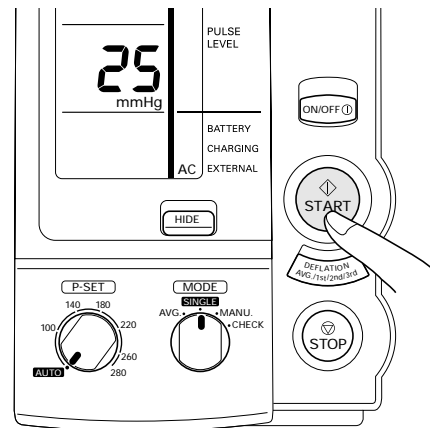
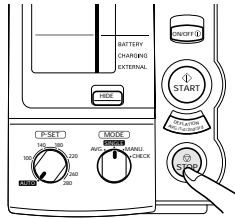

6. The measurement results are displayed.

- While the battery pack is in use, the monitor will turn off automatically in approximately five minutes and the display (measurement results) will disappear. (Automatic Power Off)

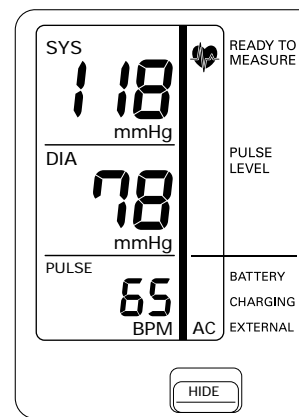

7. Push the ON/OFF (power) Button to turn off the power.

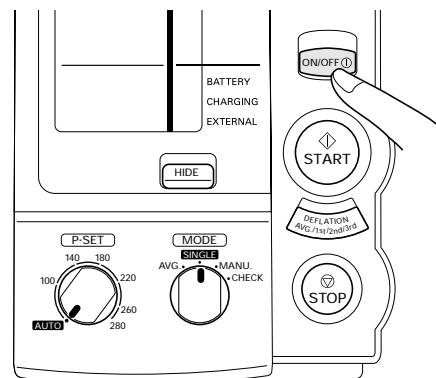

If the monitor detects a noise during the measurement or determines that the pressure value is not correct, an error display appears (Er1 to 9). In this case, refer to Page 24 for the remedial actions and start the measurement again.

# How to Measure Blood Pressure (in AVG. Mode)

1. Push the ON/OFF (power) Button to turn on the power.

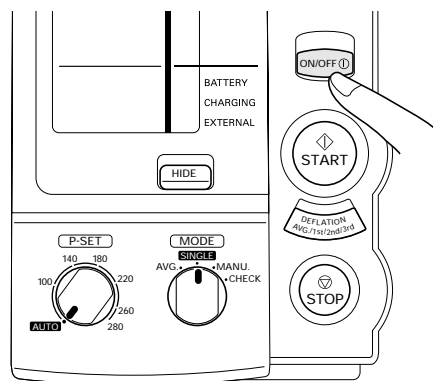

2. Set the MODE Selector to "AVG.".

The factory-set values are set as follows:

- Number of measurements: 2
- Waiting time until the 1st measurement: 0 sec.
- Interval: 1 min.

To change these factory-set values, refer to Page 10.

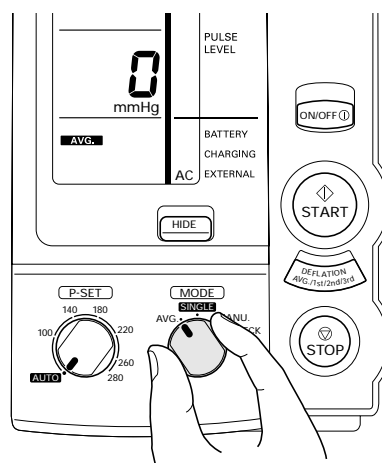

3. Set the P-SET (pressure setting) Knob to "AUTO" or the target inflation-pressure value.

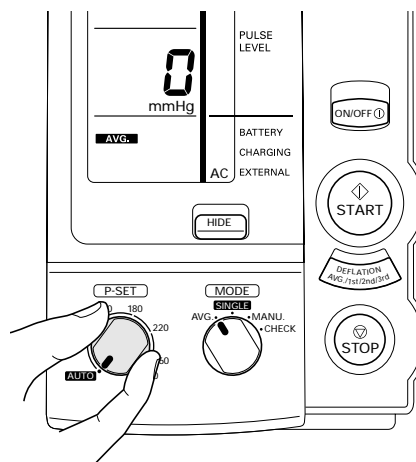

4. Wrap the cuff around the patient's arm. (Refer to Pages 11 and 12.)

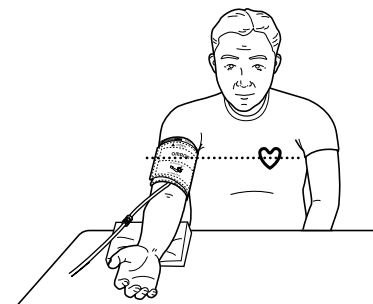

# How to Measure Blood Pressure (in AVG. Mode)

## 5. Push the START Button to start the measurement.

The unit automatically starts measurement according to the waiting time until the start of 1st measurement.

After displaying the results of 1st measurement, the monitor will measure blood pressure for the set number of times automatically at the specified intervals.

- For the setting of the number of measurements, the waiting time until the start of 1st measurement, and the interval, refer to Page 10.
- If you want to stop measurement, push the STOP Button. The unit will deflate quickly.
- If erroneous reading takes place during the measurement, the monitor will automatically start measurement again. If erroneous reading takes place twice consecutively, measurement will be stopped automatically.
- Do not push the START Button without wrapping the cuff on the arm.

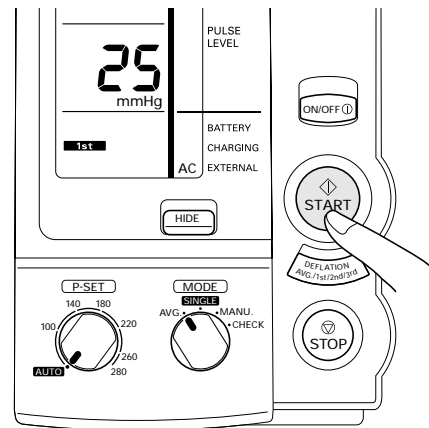

## 6. The measurement results are displayed.

After the measurement is finished, average values will be displayed.

Each time the DEFLATION (deflation control)/ Display Switch Button is pushed, the results for each measurement and the average value will be displayed.

- While the battery pack is in use, the monitor will turn off automatically in approximately five minutes and the display (measurement results) will disappear. (Automatic Power Off)

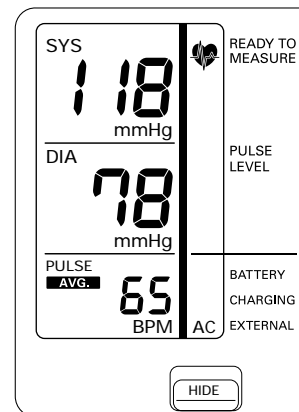

## 7. Push the ON/OFF (power) Button to turn off the power.

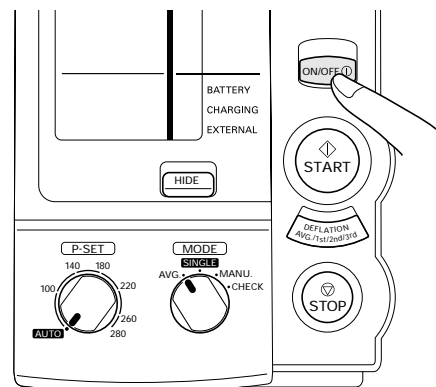

If the monitor detects a noise during the measurement or determines that the pressure value is not correct, an error display appears (Er1 to 9). In this case, refer to Page 24 for the remedial actions and start the measurement again.

# How to Measure Blood Pressure (in MANU. Mode)

1. Push the ON/OFF (power) Button to turn on the power.

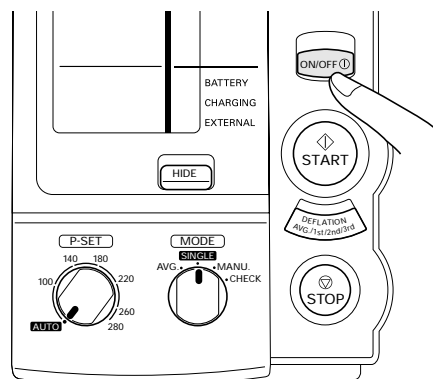

2. Set the MODE Selector to "MANU.".

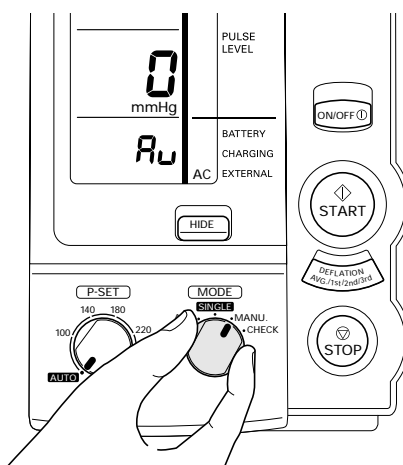

3. Set the P-SET (pressure setting) Knob to "AUTO" or the target inflation-pressure value.

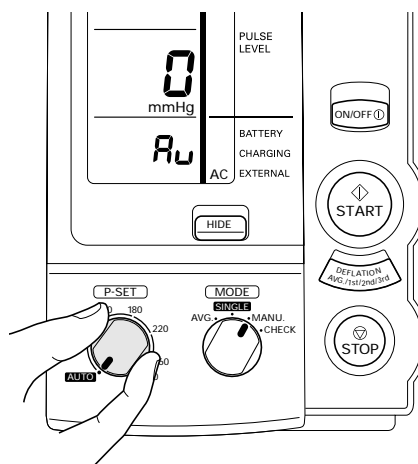

4. Wrap the cuff around the patient's arm. (Refer to pages 11 and 12.)

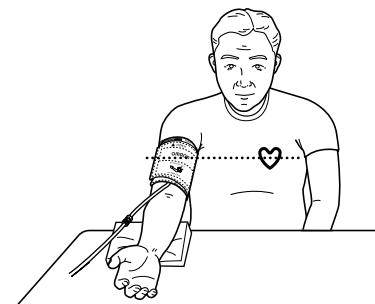

# How to Measure Blood Pressure (in MANU. Mode)

5. Place the stethoscope on the patient's arm.

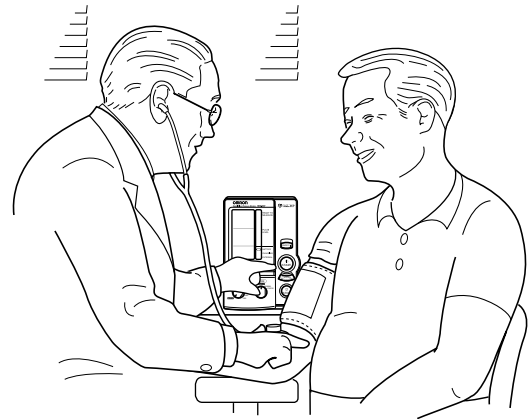

6. Push the START Button to start the measurement.

- Do not push the START Button without wrapping the cuff on the arm.

If a pulse rate is detected during deflation, the pressure display will be synchronized with the pulse rate and renewed.

- If you want to inflate again after the start of deflation, you can inflate the monitor again by pushing the START Button only while you are pushing it.
- If you want to accelerate deflation after the start of deflation, you can accelerate it by pushing the DEFLATION (deflation control) / Measurement Results Display Switch Button. Each time the Button is pushed, the deflation speed can be accelerated by approximately 5 to 10 mmHg.

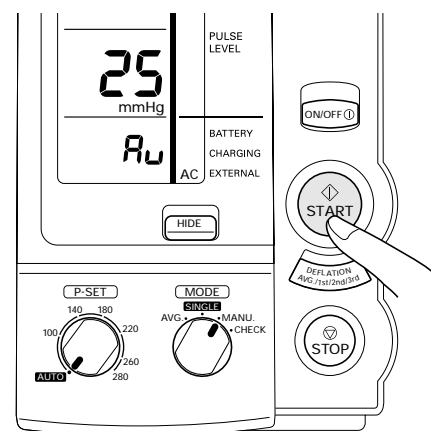

7. Push the STOP Button to finish the measurement.

- While the battery pack is in use, the monitor will turn off automatically in approximately five minutes and the display (measurement results) will disappear. (Automatic Power Off)

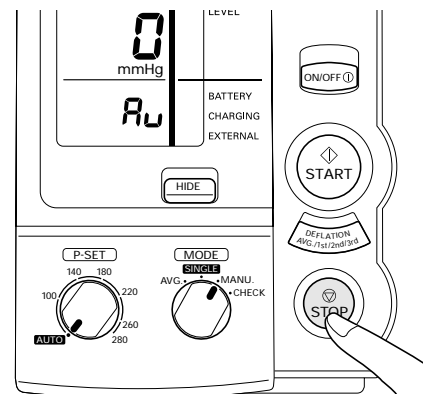

8. Push the ON/OFF (power) Button to turn off the power.

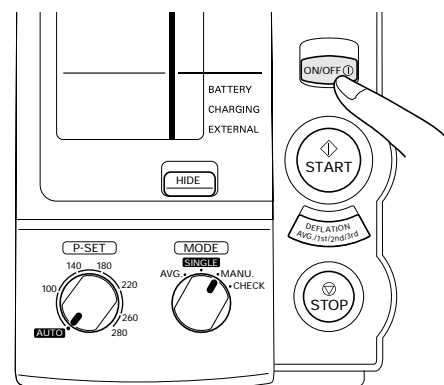

If the monitor detects a noise during the measurement or determines that the pressure value is not correct, an error display appears (Er1 to 9). In this case, refer to Page 24 for the remedial actions and start the measurement again.

# How to Measure Blood Pressure (in CHECK Mode)

Accuracy of pressure display can be checked in the CHECK Mode.

## What you need

(1) Calibrated mercury blood pressure monitor (including rubber ball), (2) T-shaped tube, (3) two air tubes, and (4) a cylindrical object to wrap the cuff such as a tea container (a sturdy one that will not break or deform under pressure)

\* Measurement error may occur even with the mercury blood pressure monitor because of insufficient amount of mercury in the mercury tank, dirty glass tube, or clogged glass tube cap.

## How to use the blood pressure monitor

1. Connect the mercury blood pressure monitor, rubber ball, and this monitor with the T-shaped tube as shown in the Figure.

2. Push the ON/OFF (power) Button to turn on the power.

3. Set the MODE Selector to "CHECK".

4. Tightly wrap the cuff over a sturdy cylindrical object.

5. Close the air release valve of the rubber ball and inflate the monitor to a certain value (pressure to be checked). The systolic and diastolic pressure values are displayed.

6. Compare the values displayed on the monitor and those on the mercury.

7. Open the air release valve of rubber ball to deflate.

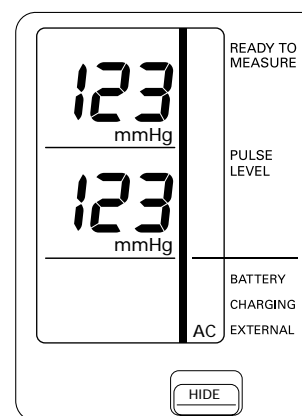
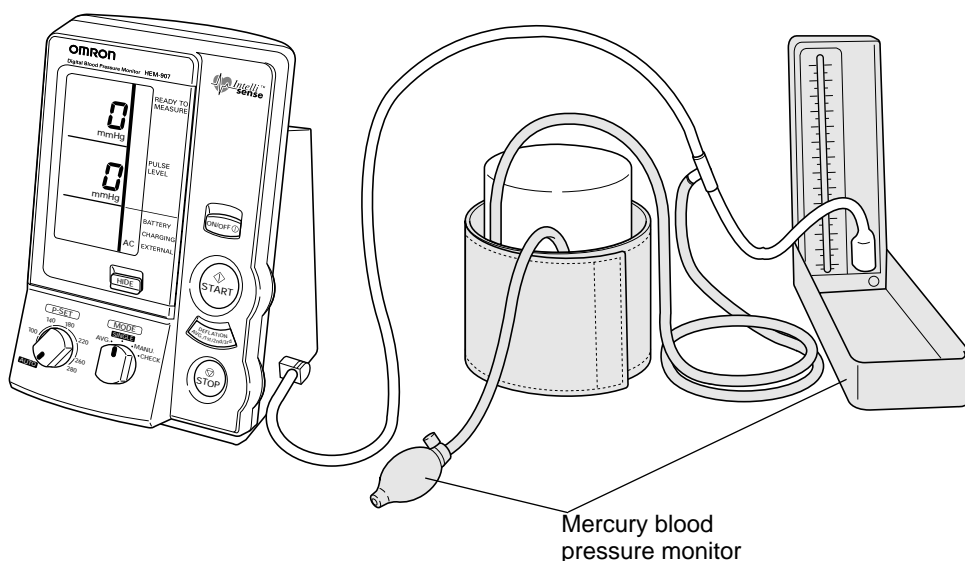

## CHECK result

(1) Generally, the test tolerance of blood pressure monitor (accuracy of pressure when shipped from the factory) should not exceed 4 mmHg.

(2) If the CHECK result shows a difference of +/- 5 mmHg or more, contact the store where you purchased this unit or the nearest OMRON dealer.

# How to Clean the Unit after Use

## ⚠ Caution

When cleaning this unit, please unplug the AC adapter from the electric outlet.  
• You may suffer electric shock.



After cleaning this unit, dry it well, then plug the AC adapter in the electric outlet.  
• You may suffer electric shock.



## General advice

- Do not clean this unit with gasoline, paint thinner, or high concentration alcohol.
- Do not disinfect this unit by autoclave or gas sterilization (EOG, formaldehyde, or high concentration ozone.)

1. Wipe the blood pressure monitor with a soft cloth squeezed well after moistened with water, diluted disinfectant alcohol, or diluted detergent.
2. Then wipe the monitor with a soft dry cloth.

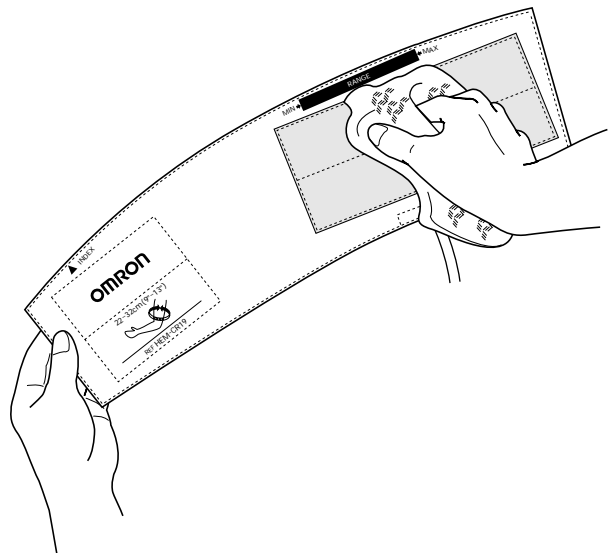
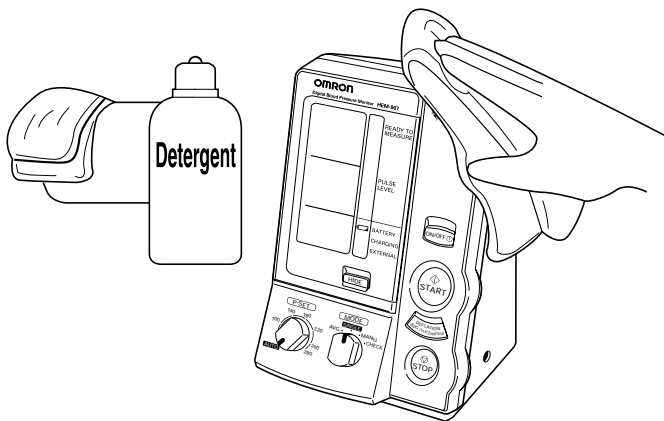



# List of Error Codes

Error code	Explanation	How to correct
Er 1	<p>Inflation error</p> <ul style="list-style-type: none"> <li>• When the pressure does not exceed 12 mmHg within the set time after the start of inflation</li> <li>• When the inflation does not reach the set cuff pressure within the specified time after the start of inflation</li> </ul>	<ul style="list-style-type: none"> <li>• Is the connector of the air tube connecting the cuff and the main unit loose? Connect it securely, then measure.</li> <li>• Is the air tube connecting the cuff and the main unit bent? Straighten it, then measure.</li> </ul>
Er 2	<p>Deflation error</p> <ul style="list-style-type: none"> <li>• When the deflation speed is too fast during measurement</li> <li>• When the deflation speed is too slow during measurement</li> <li>• When the measurement does not finish within the specified time after starting the measurement</li> </ul>	<ul style="list-style-type: none"> <li>• If the cuff is wrapped loosely, it will take longer to inflate. Wrap the cuff correctly and measure.</li> <li>• Is the bladder of cuff leaking air? Replace the bladder with new one (option).</li> </ul>
Er 3	<p>Overpressure error</p> <ul style="list-style-type: none"> <li>• The cuff pressure exceeded 299 mmHg.</li> </ul>	<ul style="list-style-type: none"> <li>• Is the air tube connecting the cuff and the main unit bent? Straighten it and measure.</li> </ul>
Er 4	<p>Insufficient inflation error</p> <ul style="list-style-type: none"> <li>• Blood pressure could not be measured due to insufficient inflation after the measurement ends.</li> </ul>	<ul style="list-style-type: none"> <li>• If the measurement is made by setting the P-SET to "AUTO", ask the patient not to move his/her arm or body during the inflation. The pressure value may be set lower during the "AUTO" measurement because of the noise.</li> <li>• Is the P-SET securely set to "AUTO"? Turn the Knob counterclockwise as far as it goes until you can hear a click sound.</li> <li>• If the measurement is made by using the pressure value setting method, set the value to 30 to 40 mmHg higher.</li> </ul>
Er 5	<p>Indeterminable blood pressure error</p> <ul style="list-style-type: none"> <li>• Blood pressure could not be measured even when the cuff pressure reached the specified pressure.</li> </ul>	<ul style="list-style-type: none"> <li>• If the cuff is wrapped loosely, correct measurement is not possible. Wrap the cuff correctly and measure.</li> </ul>
Er 6	<p>Pulse wave small error</p> <ul style="list-style-type: none"> <li>• Pulse wave was too small.</li> </ul>	<ul style="list-style-type: none"> <li>• If the cuff is wrapped loosely, correct measurement is not possible. Wrap the cuff correctly and measure.</li> <li>• If the cuff is wrapped over a thick cloth or by rolling up a jacket or a shirt, the pulse wave cannot be measured. Do not wrap the cuff over clothings.</li> </ul>
Er 7	<p>Measurement error</p> <ul style="list-style-type: none"> <li>• Relationship between systolic and diastolic pressures was abnormal.</li> </ul>	<ul style="list-style-type: none"> <li>• Check the patient if he/she has arrhythmia.</li> <li>• Ask the patient not to move his/her arm or body during the measurement.</li> </ul>
Er 8	<p>Pulse rate error</p> <ul style="list-style-type: none"> <li>• Pulse rate is not within the range of 30 to 199 beats/min.</li> </ul>	
Er 9	<p>Device error</p> <ul style="list-style-type: none"> <li>• This is an indication of trouble of the main unit.</li> </ul>	<ul style="list-style-type: none"> <li>• Contact the store where you purchased this monitor or the nearest OMRON dealer.</li> </ul>

# Troubleshooting

If trouble occurs while using the unit, please check the following.

Trouble	What to inspect	How to correct
<p>The unit inflates to abnormally high (or low) pressure.</p>	<p>Is the cuff wrapped correctly?</p>	<p>Wrap the cuff correctly, and measure again. (Refer to Page 11 and 12.)</p>
	<p>Did the patient moved his/her arm or body during inflation?</p>	<p>Ask the patient not to move his/her arm or body during measurement, and measure again.</p>
	<p>Does this trouble occur to a specific patient? For some patients with arrhythmia, this monitor may not inflate properly.</p>	<p>Set the P-SET at 30 to 40 mmHg higher than the systolic pressure of the patient, then measure.</p>
<p>The monitor cannot measure blood pressure.</p> <p>Measured values are abnormally high (or low).</p>	<p>First of all, check the patient's condition.</p>	<p>After checking the patient with the stethoscope as needed, take appropriate measure as in the "List of error codes". (Refer to Page 24.)</p>
	<p>Did the patient moved his/ her arm or body during measurement?</p>	<p>Ask the patient not to move his/her arm or body during measurement, and measure again.</p>
	<p>Does the patient have arrhythmia?</p>	<p>Check the patient with a stethoscope.</p>
	<p>Is the size of the cuff correct and is it wrapped correctly?</p>	<p>Select the cuff according to the patient's arm circumference, wrap it correctly, then measure again. (Refer to Pages 11 and 12.)</p>
	<p>Is the level of the brachium to which the cuff is wrapped at the same level as the heart?</p>	<p>Keep the level of the brachium to which the cuff is wrapped at the same level as the heart, then measure again. (Refer to Page 12.)</p>

# Specifications

Name:	OMRON Digital Automatic Blood Pressure Monitor
Model:	<b>HEM-907</b>
Display:	Digital display
Measurement:	Oscillometric method
Measurement Range:	Pressure; 0 to 299 mmHg Pulse rate; 30 to 199 beats/min
Accuracy:	Pressure; Within $\pm 4$ mmHg Pulse rate; Within $\pm 5\%$ of reading
Inflation:	Automatic inflation with pumping
Deflation:	Automatic deflation by electromagnetic control valve
Air Release:	Automatic rapid air release by electromagnetic control valve
Pressure Detection:	Electrostatic capacity semi-conductor pressure sensor
Power supply:	AC adapter (230 $\pm$ 10 VAC, 50/60 Hz or 110 VAC, 60 Hz or 240 V $\pm$ 10 VAC, 50Hz)* or Battery pack (4.8 VDC, 6W)
Electric Shock Protection Method:	Class II B type
Operating Temperature and Humidity:	10 to 40°C, 30 to 85% RH
Weight of Main Unit:	Approx. 910 g
External Dimensions:	Approx. 139 (W) x 203 (H) x 131 (D) mm
Accessories attached:	Cuff / bladder set M, AC adapter, air tube (1.0 m), Instruction Manual
Options:	Cuff / bladder set L, cuff / bladder set M, cuff / bladder set S, Cuff L (with no bladder), cuff M (with no bladder), cuff S (with no bladder), Bladder L, bladder M, bladder S, Air tube 1.0 m, air tube 1.3 m, Battery pack, AC adapter, Stand exclusive for this unit, wall-hanging kit, pole-mounting kit

\* AC adapter type to be specified at purchase.

[ Please note that specifications may be changed without prior notice.]

# Exemptions

---

OMRON Will not bear any responsibilities on the following matters.

1. When a trouble and/or damage occurs caused by the maintenance and/or repair conducted by a person other than OMRON or the dealer specified by OMRON
2. The trouble and/or damage of OMRON product caused by the product of other manufacturer not delivered by OMRON
3. The trouble and/or damage caused by the maintenance and/or repair using the repair parts not specified by OMRON
4. The trouble and/or damage caused by the results not observing the Notes on Safety or the operational method mentioned in this Instruction Manual
5. Under the circumstances not within the operating conditions of this unit including the power source or the setting environment mentioned in this Instruction Manual
6. The trouble and/or damage caused by the result(s) of remodeling or improper repair of the product
7. The trouble and/or damage caused by act of god such as fire, earthquake, flood, or thunders

1. The contents of this Instruction Manual may be changed without prior notice.
2. We have prepared the contents of this Instruction Manual with thoroughgoing measures. However, if an inadequate description or error is found, please let us know.
3. It is prohibited to copy a part or an entire part of this Instruction Manual without getting OMRON's permission. Unless this Instruction Manual is used by an individual (company), it cannot be used without getting OMRON's permission from the standpoint of the Copyright Law.

# MEMO

# MEMO

# MEMO

# OMRON

**OMRON Corporation**

3-4-10, Toranomom, Minato-ku,  
Tokyo 105-0001, Japan

**OMRON HEALTHACARE SINGAPORE PTE LTD**

83 Clemenceau Avenue, #11-01 UE Square  
Singapore 239920